

FRENCH DOOR REFRIGERATOR

EI23BC82SS

Featuring IQ-Touch™ Electronic Controls



PRODUCT DIMENSIONS

Height	69-7/8"
Width	36"
Depth	28-1/2"

MORE EASY-TO-USE FEATURES

IQ-TOUCH™ CONTROLS DISPLAY ALL YOUR OPTIONS

For those who like to have their options always visible, the IQ-Touch™ control panel displays all of your options, at all times.

PLATINUM STAR® LIMITED WARRANTY

Our exclusive limited warranty that includes three years coverage on parts and one year on labor.*

LUXURY-DESIGN® GLASS SHELVES

Fit even large entertaining platters with sleek, spacious glass shelves.

LUXURY-DESIGN® LIGHTING

Our designer LED lighting ramps up and is as beautiful as it is functional.

LUXURY-GLIDE® FREEZER DRAWERS FOR EFFORTLESS ACCESS TO ITEMS

Access it all — our Luxury-Glide® Freezer drawers glide out smoothly and fully extend, letting you see every last item inside.

PUREADVANTAGE® FILTRATION SYSTEMS

Our filtration system keeps clean, filtered air circulated throughout and our 3M® water filter keeps fresh, clean water and ice at your fingertips.

STAY INFORMED WITH THE REFRIGERATION ALARM SYSTEM

Rest assured with our Refrigeration Alarm System, which alerts you to important changes, including power failures, an open door and elevated freezer temperatures.

FULL-EXTENSION FREEZER BASKETS

Baskets give you additional functional space to organize and store more.

Available in:



Stainless
(S)

*Eligibility based on product registration with Electrolux North America within 60 days of purchase. Products must have been purchased on or after July 1, 2013. Coverage includes material parts for 3 years and labor for 1 year.

SIGNATURE FEATURES



PERFECT TEMP® DRAWER KEEPS FAVORITES AT THEIR IDEAL TEMPERATURE

Delight your guests by serving everything at its ideal temperature — the Perfect Temp® Drawer offers a customizable range of 28-38 degrees and preset options for favorites, such as wine and cheese.



CRISPER DRAWERS KEEP FRUITS AND VEGGIES AT THEIR MOST DELICIOUS

Veggies and fruits retain their just-picked taste with our Adjustable Humidity-Controlled Crisper Drawers that lock in freshness longer.



COUNTER-DEPTH DESIGN

Gives you a sleek built-in look.



SELF-CLOSING DOORS GIVE YOU PEACE OF MIND

Maintain your desired temperature in the refrigerator while never worrying about accidentally leaving the door open.

FRENCH DOOR REFRIGERATOR

EI23BC82SS



23 CU.FT. COUNTER-DEPTH FRENCH DOOR REFRIGERATOR

CAPACITIES

Total Capacity	22.3 Cu. Ft.
Fresh Food Volume	15.46 Cu. Ft.
Freezer Volume	6.82 Cu. Ft.
Total Shelf Area	27.4 Sq. Ft.
Fresh Food Shelf Area	21.77 Sq. Ft.
Freezer Shelf Area	5.67 Sq. Ft.

EXTERIOR

Signature Soft-Arc Door and Handle Design	Yes
Electronic Controls	iQ-Touch™
Hidden Hinge Door Design	Yes

FRESH FOOD CONVENIENCES

PureAdvantage® Water & Ice	Yes
PureAdvantage® Air Filtration /Water Filter Location	Yes /Top Right
Temp Alarm System /Door Ajar Alarm	Yes /Yes
Power Failure Alarm	Yes
Luxury-Design® Glass Shelves	Flat, Lift-Off
Humidity-Controlled Left Crisper	Luxury-Glide®
Humidity-Controlled Right Crisper	Luxury-Glide®
Perfect Temp® Drawer	Luxury-Close™
Wine and Beverage Rack	Yes
Clear Gallon Door Bins (Adjustable)	2
Clear 1/2-Gallon Door Bins (Adjustable)	2
Clear Condiment Bin	1
Clear Tilt-Out Can Racks	2
Luxury-Design® LED Ramp-Up Multilevel Lighting	Yes
Automatic Ice Maker	

FREEZER CONVENIENCES

Automatic Ice Maker	Yes
Luxury-Glide® Self-Closing Drawer	Yes
Sliding Freezer Baskets	Yes
Soft Freeze™ Bin/Wire Pizza Slot	No /Yes
Plastic Basket Tray	Yes
Luxury-Design® LED Ramp-Up Multilevel Lighting	Yes

ADDITIONAL FEATURES

ENERGY STAR®	
Sabbath Mode (Star-K® Certified)	Yes

SPECIFICATIONS

Color –	
Stainless Steel	S
Power Supply Connection Location	Right Bottom Rear
Water Inlet Location	Left Bottom Rear
Voltage Rating	120V /60 Hz
Connected Load (kW Rating) @ 120 Volts†	1.02
Minimum Circuit Required (Amps)	15
Shipping Weight (Approx.)	347 Lbs.

† An electrical supply with grounded three-prong receptacle is required. The power supply circuit must be installed in accordance with current edition of National Electrical Code (NFPA 70) and local codes & ordinances.

NOTE: Always consult local and national electric and plumbing codes. Refer to Product Installation Guide for detailed installation instructions on the web at electroluxappliances.com. Specifications subject to change.

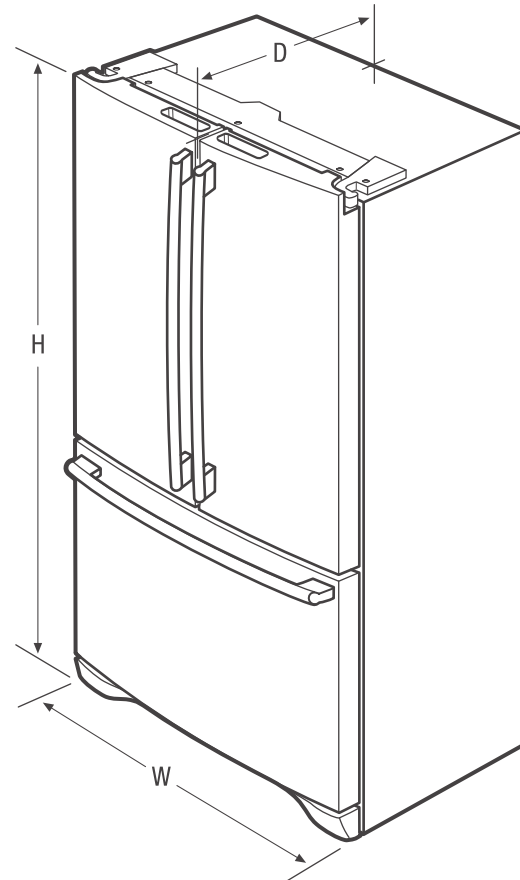

PRODUCT DIMENSIONS

Height (Including Door)	70-1/8"
Width	36"
Depth (Including Door)	28-1/2"
(with Door 90° Open)	42-1/2"
(with Drawer Fully Extended)	46"

Electrolux Major Appliances, N.A.

USA • 10200 David Taylor Drive • Charlotte, NC 28262 • 1-877-4electrolux (1-877-435-3287) • electroluxappliances.com
 CANADA • 5855 Terry Fox Way • Mississauga, ON L5V 3E4 • 1-800-265-8352 • electroluxappliances.ca

EI23BC82S 10/16

© 2016 Electrolux Home Products, Inc.



High standards of quality at Electrolux Home Products, Inc. mean we are constantly working to improve our products. We reserve the right to change specifications or discontinue models without notice.

FRENCH DOOR REFRIGERATOR

EI23BC82SS

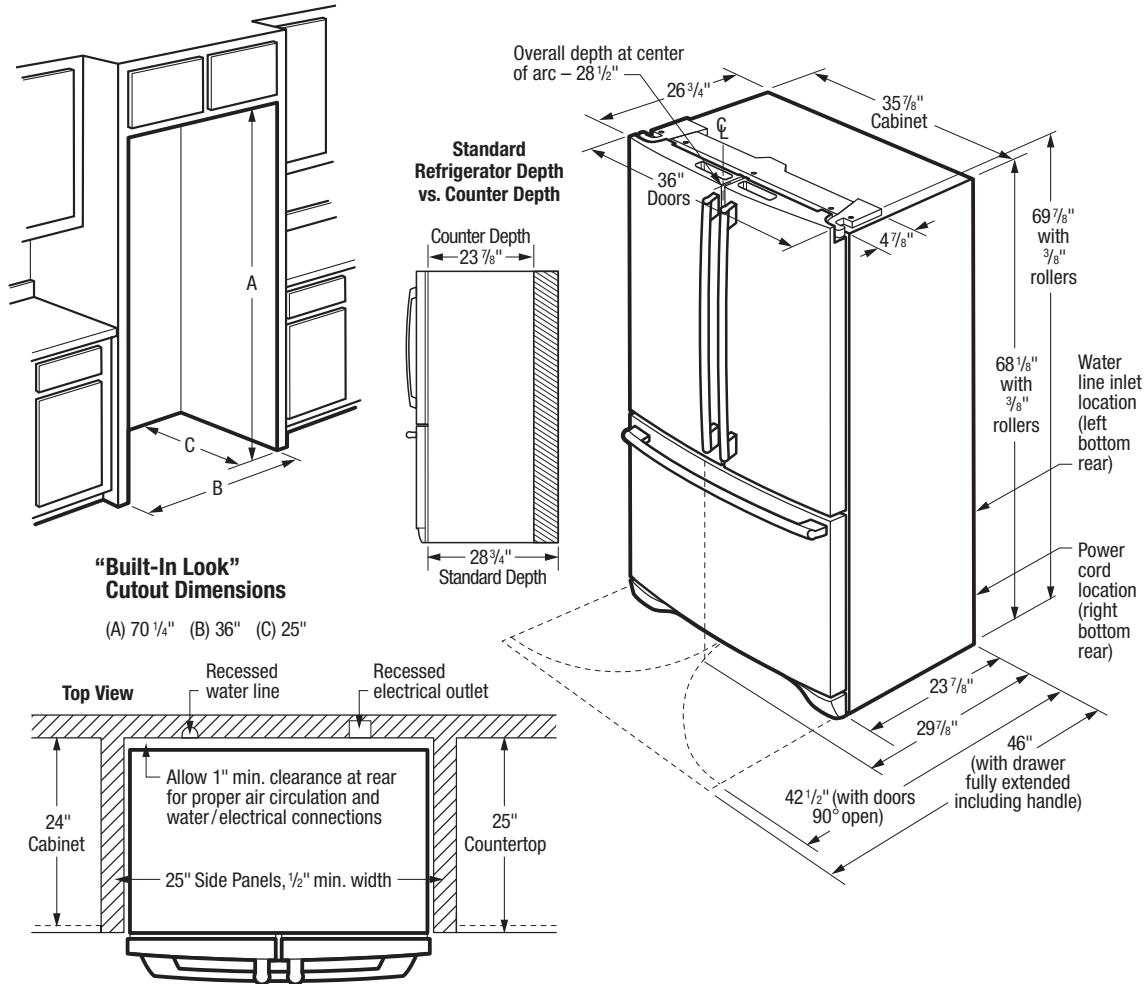

Counter-Depth French Door Refrigerator Specifications

- Product Weight – 342 Lbs.
- An electrical supply with grounded three-prong receptacle is required. The power supply circuit must be installed in accordance with current edition of National Electrical Code (NFPA 70) and local codes & ordinances.
- Voltage Rating – 120V/60 Hz
- Connected Load (kW Rating) @ 120 Volts = 1.02 kW
- Amps @ 120 Volts = 15 Amps
- Always consult local and national electric & plumbing codes.
- Floor should be level surface of hard material, capable of supporting fully loaded refrigerator.
- When installing refrigerator adjacent to wall, cabinet or other appliance that extends beyond front edge of unit, 20" minimum clearance recommended to allow for optimum 120° to 180° door swing, providing complete drawer/crisper access and removal. (*Absolute 4-1/2" minimum clearance will ONLY allow for 90° door swing which will provide drawer/crisper access with restricted removal.*)
- To ensure optimum performance, avoid installing in direct sunlight or close proximity to range, dishwasher or other heat source.

- For proper ventilation, front grille **MUST** remain unobstructed.
- Recess electrical outlet when possible.
- Water recess on rear wall recommended to prevent water line damage.
- Water Pressure – Cold water line must provide between 30 and 100 pounds per square inch (psi).
- Copper tubing with 1/4" O.D. recommended for water supply line with length equal to distance from rear of unit to household water supply line plus 7 additional feet. Optional Water Supply Installation Kits available.
- Adjustable front rollers to assist with door alignment.

“Built-In Look” Specifications

- Minimum opening of 70-1/4" H x 36" W x 25" D required to allow for ease of installation, proper air circulation, and plumbing/electrical connections.
- Remove all wall/floor molding prior to installation.

Note: For planning purposes only. Refer to Product Installation Guide on the web at electroluxappliances.com for detailed instructions.

Electrolux Major Appliances, N.A.

USA • 10200 David Taylor Drive • Charlotte, NC 28262 • 1-877-4electrolux (1-877-435-3287) • electroluxappliances.com
 CANADA • 5855 Terry Fox Way • Mississauga, ON L5V 3E4 • 1-800-265-8352 • electroluxappliances.ca

EI23BC82S 10/16

© 2016 Electrolux Home Products, Inc.



High standards of quality at Electrolux Home Products, Inc. mean we are constantly working to improve our products. We reserve the right to change specifications or discontinue models without notice.